

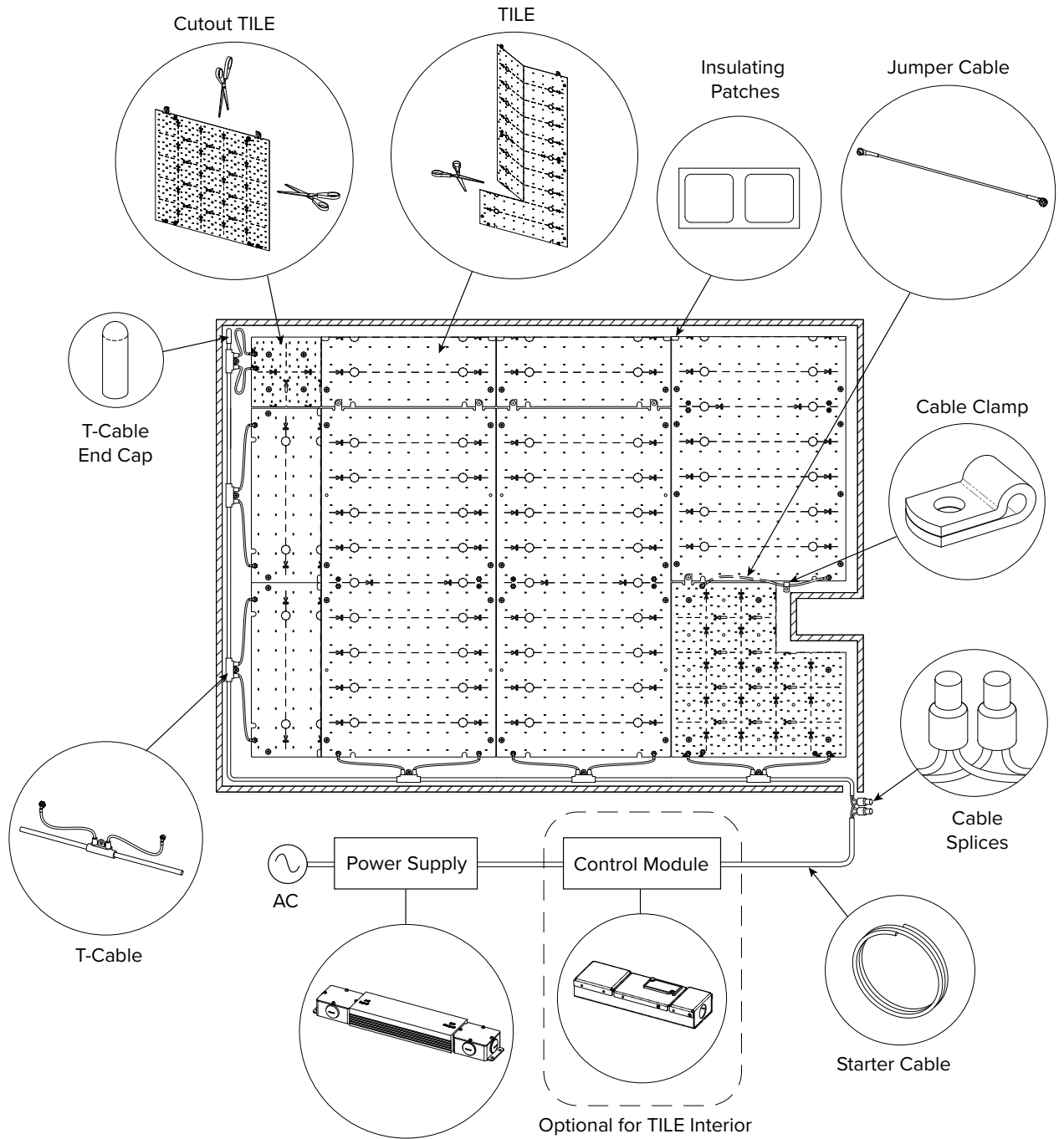

COOLEGE TILE GEN2 INTERIOR TUNABLE WHITE INSTALLATION MANUAL



Caution: Observe precautions for handling electrostatic sensitive devices.



In Canada, TILE Interior must be installed within an enclosure

RoHS



5 Year Limited Warranty: Parts and workmanship

Cooledge Lighting Inc.
110-13551 Commerce Parkway
Richmond, BC V6V 2L1 Canada

O +1 604 273 2665
F +1 604 273 2660
T +1 844 455 4448
W cooledgelighting.com

Cooledge Lighting reserves the right to change materials or modify the design of its product without notification as part of the company's continuing product improvement program.

CONTENTS

1.0 Important Installation Notes	3
2.0 System Contents	3
3.0 Introduction to TILE Interior	6
4.0 Care and Handling Guidelines	6
5.0 System Layout	7
6.0 Example Installation	8
7.0 Installation	9
7.1 Mount the 1st Run of TILE Interior	9
7.2 Cutting TILE Interior	13
7.3 Mount the Additional Runs of TILE Interior	14
7.4 Install the Last Run (if less than 12" (305mm) width)	15
7.5 Install the Last Corner	16
7.6 Install T-Cables	17
7.7 Disassembling TILE Interior (if required)	18
7.8 Reuse of Input End of TILE (if required)	19
8.0 TILE Interior Layout Guidelines	20
8.1 Maximum Run Length	20
8.2 Maximum Distance Between Control Module and Tile Interior	20
9.0 Troubleshooting	22
10.0 Product Support	22
11.0 Warranty	22

1.0 IMPORTANT INSTALLATION NOTES

Please read instructions prior to installation

Installation must be completed by a qualified electrician in accordance with all national and local electrical and construction codes.

Ensure power is off prior to installation.

TILE products are dry location rated only.

Mounting surface must be non-conductive (eg. drywall, plywood, etc)

TILE products must be powered by a Cooledge approved constant voltage Class 2 or LPS LED Driver.

Using a non-approved power source could damage the system and will void the warranty.

 DO NOT DISCARD the contents of the Installation Kit. All components will be needed to perform the installation.

2.0 SYSTEM CONTENTS

A. TILE Interior/Tunable White:	Light emitting sheets packaged in quantities of 1–50 pieces.
B. TILE Starter Kit:	Contains: (1) Quick Start Guide, (2) Splice Connectors, (4) T-cable End Caps, (1) 16AWG (1.3mm ²) Starter Cable, 10ft (3m) long, for connection between Control Module and T-Cable. (4) Cut Tile Reuse Jumper Cables - for reusing TILES that have been cut (10) Insulating Patches - required for covering edges of cut TILES.
C. Power Supply:	Converts incoming AC power to 58Vdc output.
D. Control Module:	Converts incoming control signals to dim or (where applicable) tune the CCT of the TILES. The Control Module has one input connection from the power supply and up to 4 max. 90W output connections to TILES.
E. TILE Cutout Kit (optional):	Contains a Cooledge Cutout TILE with adhesive backing strips and an additional Connector kit with a longer “double jumper” connector.
F. TILE T-Cable	16AWG (1.3mm ²) 2-conductor jacketed cable with four (“T-4”) or ten (“T-10”) “T” connections consisting of a splice and two 18AWG (0.8mm ²) conductors with snap connectors. It is used to connect the Starter Cable to the TILES.
G. TILE Starter Cables:	10’ (3m) length 16AWG (1.5mm ²) cables for connection of the TILES to the control module or power supply.
H. TILE Interior Extension Cables (optional):	14AWG (1.5mm ²) 2-conductor jacketed cable of 10’(3m) or 20’(6m) length to connect the Starter Cable to the Control Module (or power supply for installations less than 100 watts) when a remote mounting distance greater than 10’(3m) is required.

A. TILE INTERIOR/TUNABLE WHITE

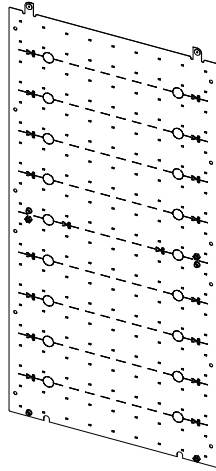

B. TILE STARTER KIT

CUT TILE REUSE JUMPER CABLE
X 4

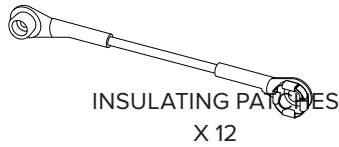

INSULATING PATCHES
X 12

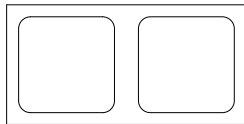

SPLICE CONNECTOR
X 4

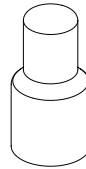

T-CABLE END CAP
X 4



16AWG (1.3mm²) CONDUCTOR CABLE
10ft (3m) LENGTH
X 2

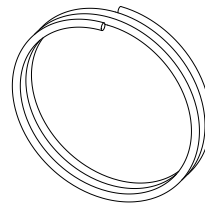

C. POWER SUPPLY

- Converts from line voltage to 58Vdc
- Power supply appearance may vary depending on model ordered

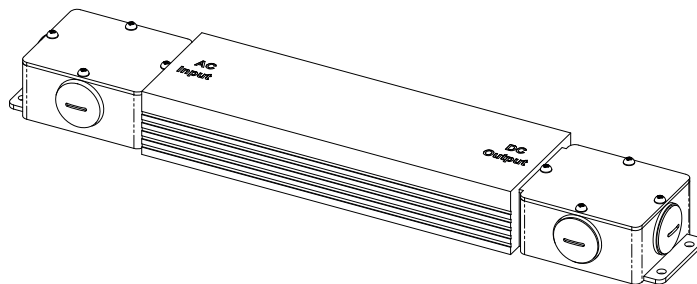

D. CONTROL MODULE (OPTIONAL)

- Uses incoming control signals to dim or (where applicable) tune the CCT of the TILES.

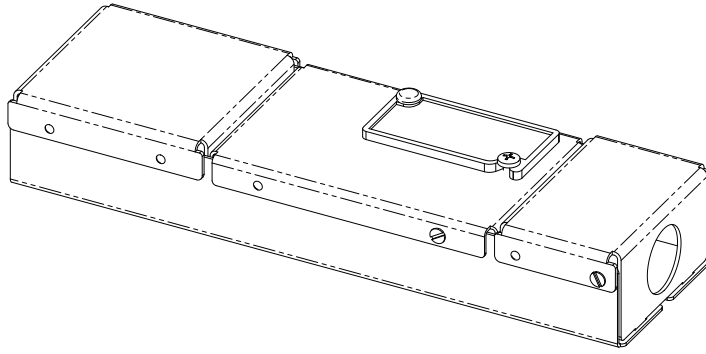

E. CUTOUT KIT (OPTIONAL - DEPENDING ON DESIGN LAYOUT)

- TILE Cut-out may be cut in both directions to fit around obstacles on the mounting surface
- Jumper cables can be used to feed power between a TILE and a TILE Cut-out when one or more of the corners of the Tile Cut-Out have been removed.
- Cable clamp is used to secure the jumper cables

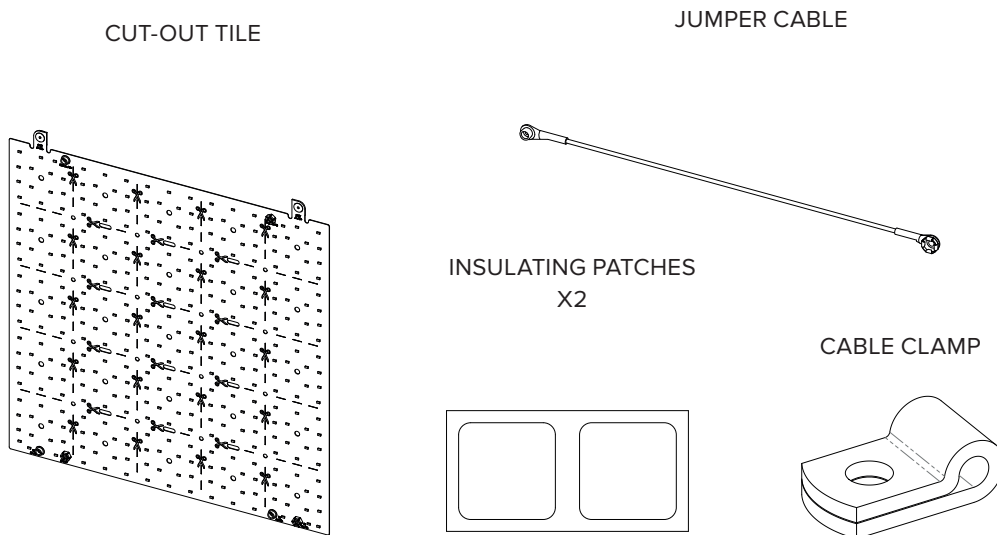

F. T-CABLE

- Makes the power connection between the Starter Cable and the TILES
- Supplied in 4T and 10T configurations
- May be cut shorter if required

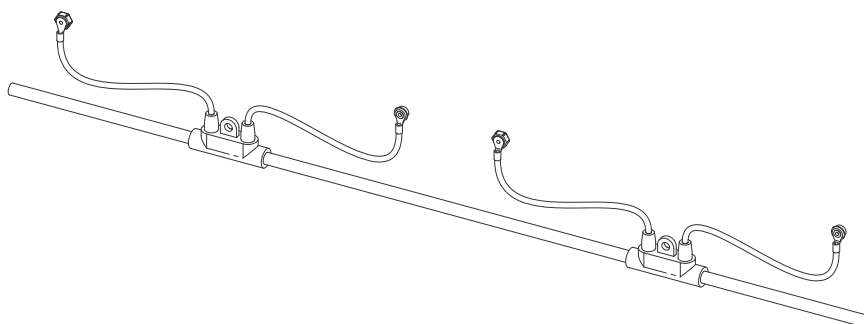

3.0 INTRODUCTION TO TILE INTERIOR/TUNABLE WHITE

TILE Interior/Tunable White provides a flexible means of illuminating large areas. TILES can be connected in series using snap connectors and can be installed on both flat and curved surfaces.

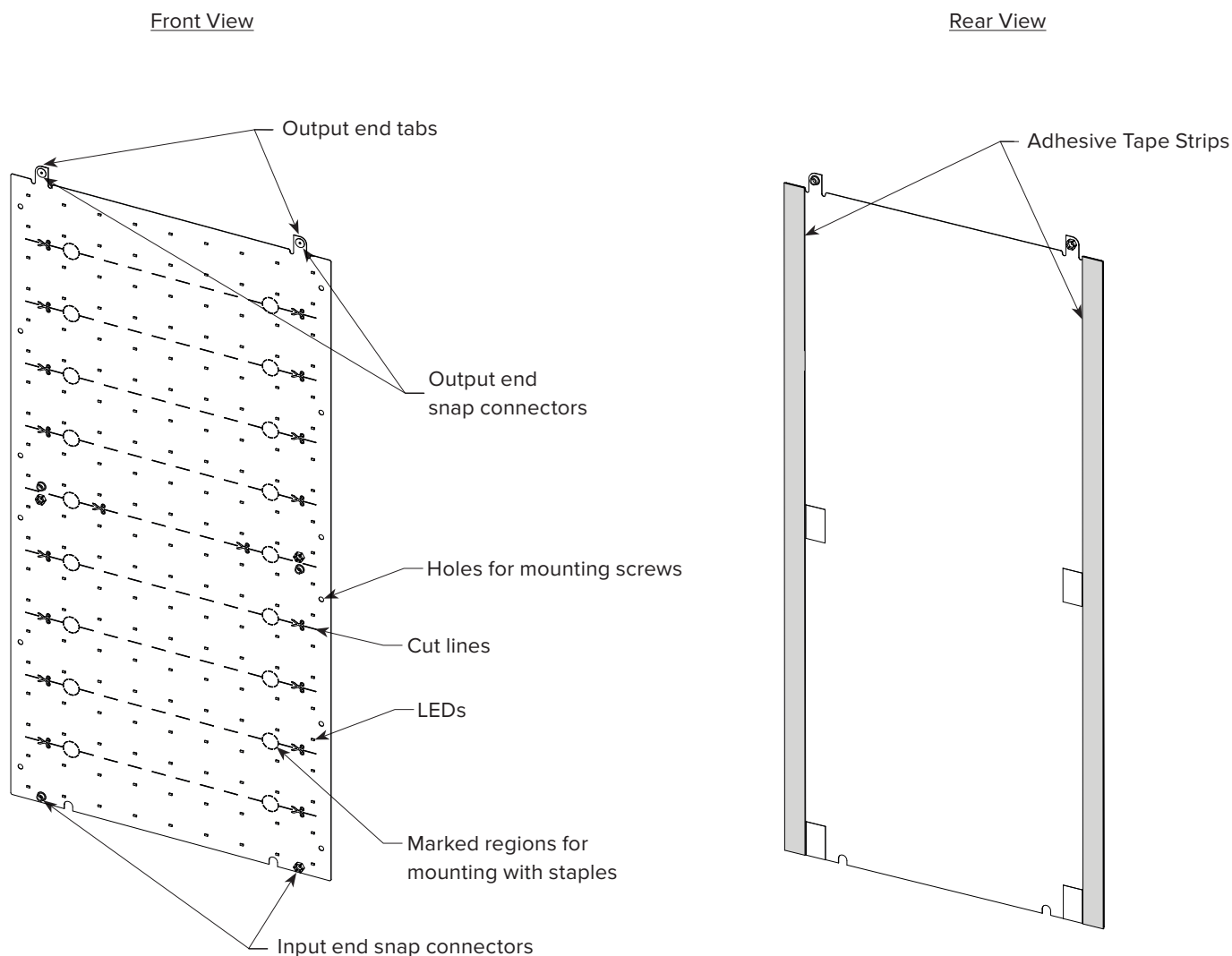

4.0 CARE AND HANDLING GUIDELINES

Always handle TILES along the outer edges of the sheet.

Avoid handling, scraping, rubbing or wiping the front surface of the sheet. Although the LEDs and drive components are bonded strongly to the base material, it is possible to remove them or damage the electrical connection if not handled with care.

Avoid penetrating the sheet at any location other than along the cut lines or in the marked knockout holes.

As with all electronics, light sheets are susceptible to damage from Electrostatic Discharge (ESD). Where possible avoid situations that are conducive to creating static.

Avoid creasing or repeated flexing of TILE as this may cause separation in the traces of the electrical circuits located on the surface of the sheets.

5.0 SYSTEM LAYOUT

 BEFORE STARTING installation carefully consider your system layout (refer to project shop drawings if available):

- Refer to section 8 “TILE Interior/Tunable White zLayout Guidelines” for details regarding the maximum number of TILES per power supply. This number is also dependent on the arrangement of the sheets.
- Each TILE illuminates a 300mm x 600mm (approx 1' x 2') area.
- TILES are joined electrically by attaching the two (2) sets of snap connectors.

 DO NOT CONNECT more than one (1) power supply to one (1) light sheet electrical circuit. A light sheet electrical circuit includes any TILES that are in electrical contact with each other on the output side of the control module or power supply. Circuits must be 90W maximum.

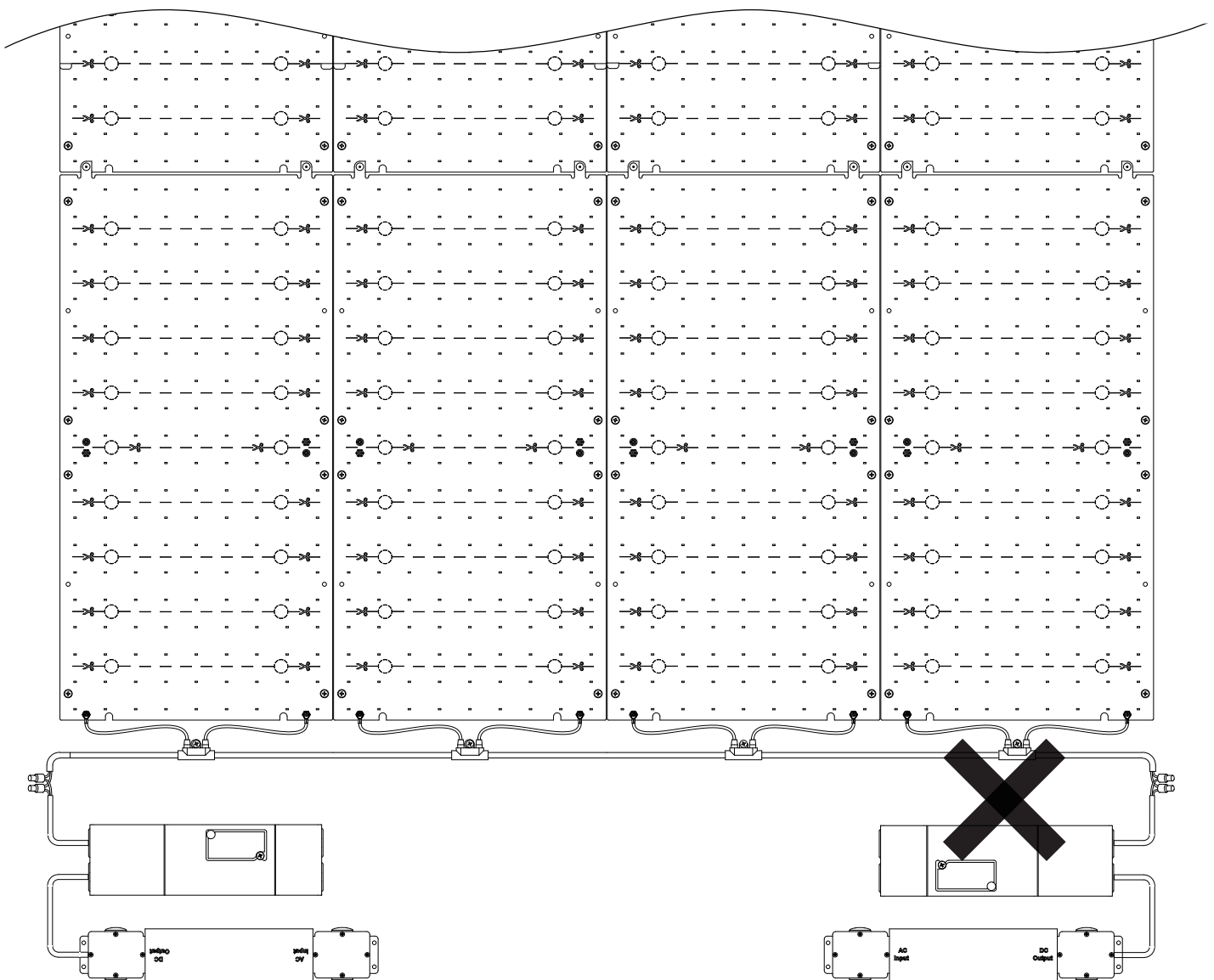

6.0 EXAMPLE INSTALLATION

The installation below shows four (4) runs of TILE. Each run consists of two (2) TILE sheets connected in series. The Power Supply or Control Module is connected to the system via the T-Cable and Starter Cable.

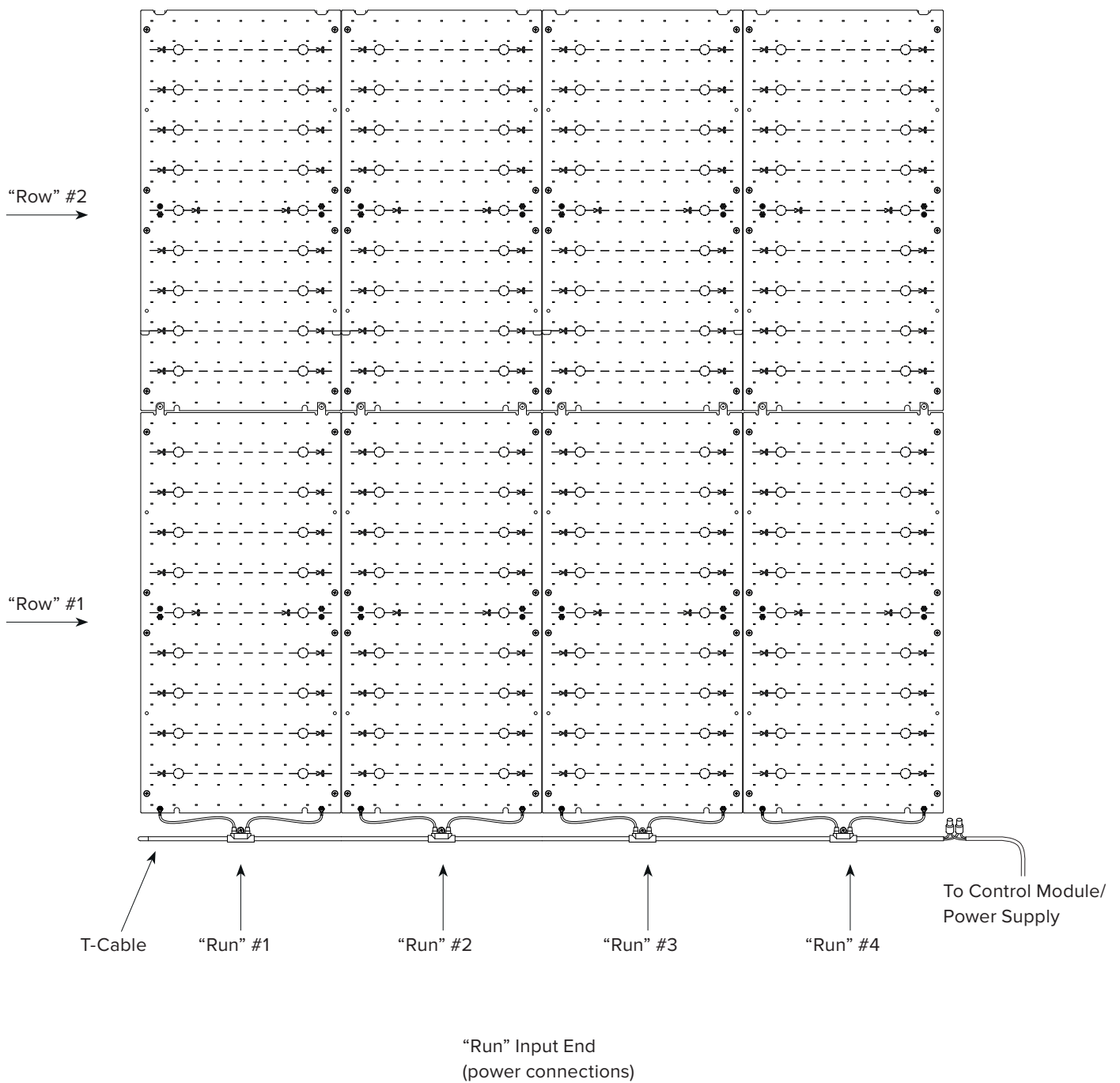

NOTE: Some layouts will require a TILE to be cut at the termination end of the run to fit into the area provided for mounting. Additionally, if runs are required that are less than the width of a TILE, the layout will require that the TILES be cut and rotated to fill the space. Please refer to Section 7.3: "Cutting TILE" for detailed instructions on how to do this.

7.0 INSTALLATION

-  DO NOT CONNECT the T-Cable at the output (tab) end of the TILE. The T-Cable can only be connected at the input end of the sheet.

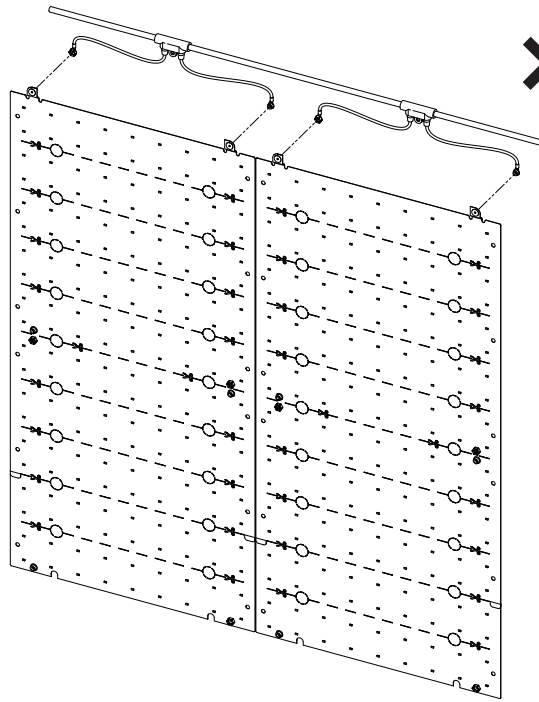

 DO NOT connect T-Cables to TILE tabs.

7.1 MOUNT THE 1ST RUN OF TILES

1. Mechanical fasteners are required for installation of TILE. Either screws or staples may be used. For ceiling mounted applications or where flatness is critical it is recommended to also use the double sided tape which has been applied to the back of the sheets prior to applying the mechanical fasteners.

If using the tape, remove the liner from the tape and carefully place the TILE in position, one side at a time. The tape is pressure sensitive and must be pressed down firmly along its entire length in order to form a strong bond with the mounting surface.

-  This step must be performed with great care because it is not possible to reposition the sheet once it has been taped down.

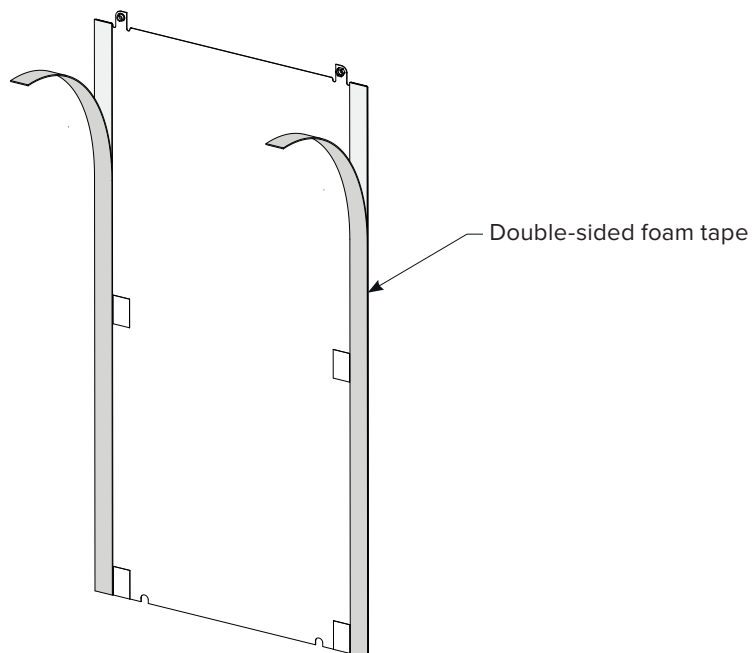

2. Beginning at the input end of a run, position the first TILE where required. Fasten the sheet to the mounting surface using #8 (or M4) fasteners appropriate for the mounting surface. It is recommended to use nylon washers to prevent damage to TILE.

Mount Using Screws

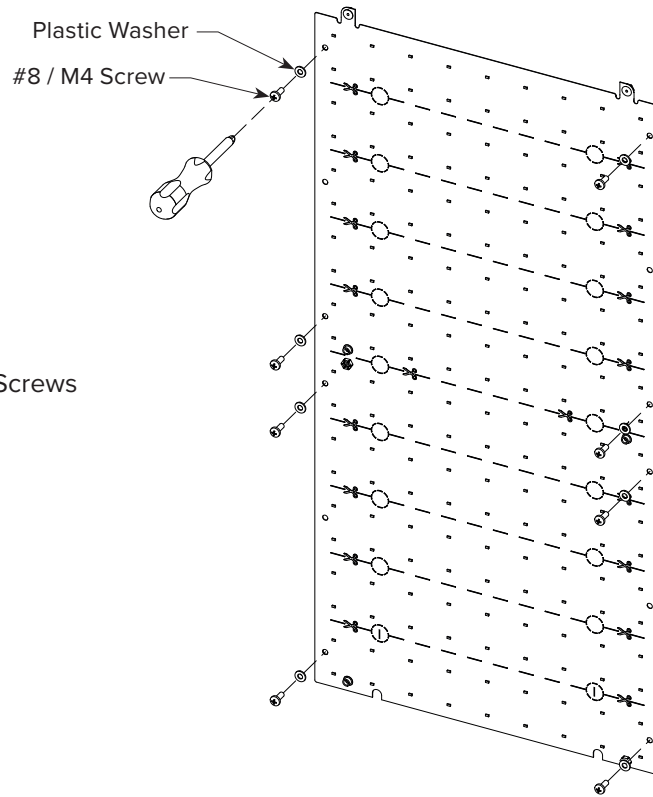

or

Mount Using Staples

- An electric staple gun is recommended
- Maximum staple width = 1/2" (13mm)

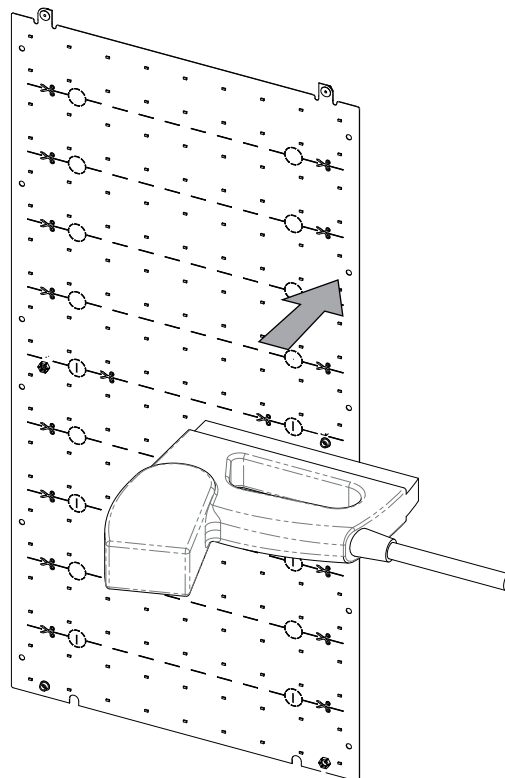

3. Slide the next TILE under the tabs of the first. Ensure that the flexible tabs on the first TILE sit on top of the second.

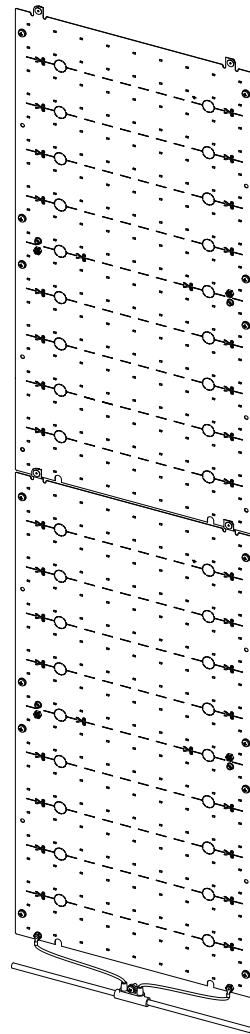

4. Make the electrical connection between the two (2) TILES by gently pressing the snap connectors on the overhanging tabs down until they click together.

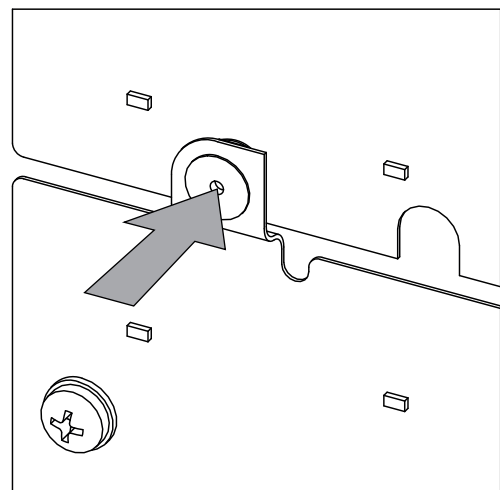

 **CAUTION:** Disconnecting and reconnecting jumpers may damage the connectors on the sheets if repeated more than 3 times. See Section 7.8 for recommended method.

5. Once the second TILE is aligned correctly, attach it in place as in Steps 1 and 2.
6. Repeat steps 3, 4 and 5 until the run is complete. For runs that terminate in a full length TILE, please refer to Steps 7 and 8. For runs where the TILE at the termination end must be cut to fit into the allowable space, please refer to Section 7.3: Cutting TILE.
7. At the termination end of the run, cut the tabs of the top row of the TILE as shown.

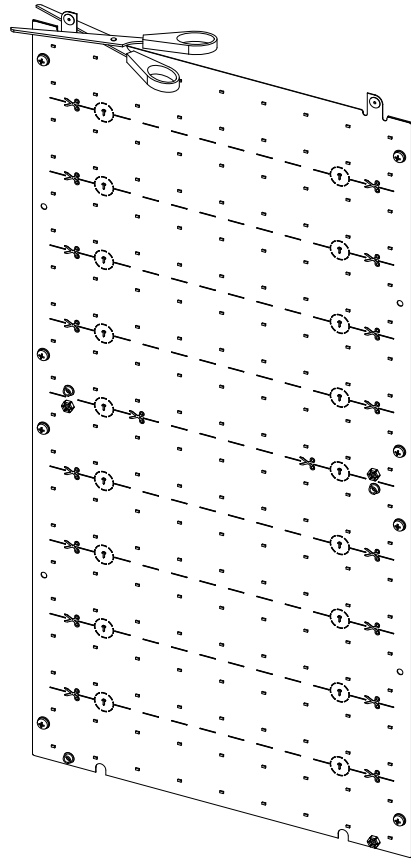

8. Place insulating patches over region of exposed TILE where tabs were cut, as shown.

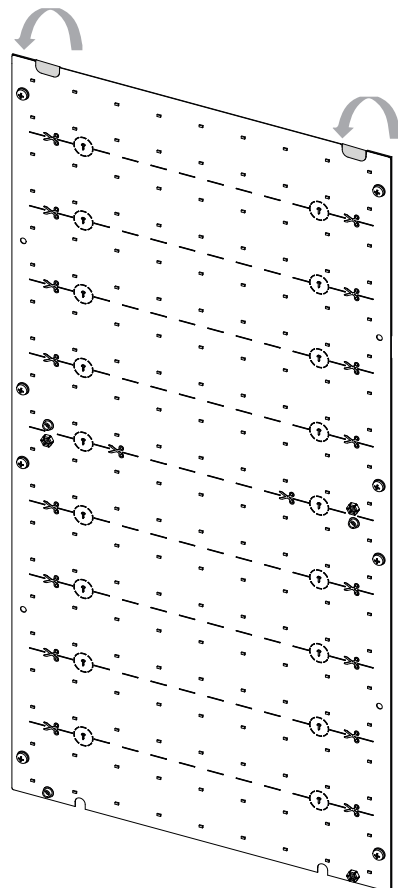

7.2 CUTTING TILE

! TRIM ONLY ALONG THE CUT LINES SHOWN ON THE TILE.

TILES may be cut to shorter lengths if required. The cut TILE must always be placed at the termination end of a run as it can no longer be connected to an additional TILE. Cut TILES before mounting.

To cut the TILE, use sharp scissors or snips. Carefully cut along the black line indicated by the scissor symbol.

A TILE can be cut to give 11.8" (300mm) wide x lengths of approximately 2.36" (60mm) as shown.

! Refer to section 7.8 Reuse of Input End of TILE for cases where the cut pieces of TILE may be used in other parts of the layout.

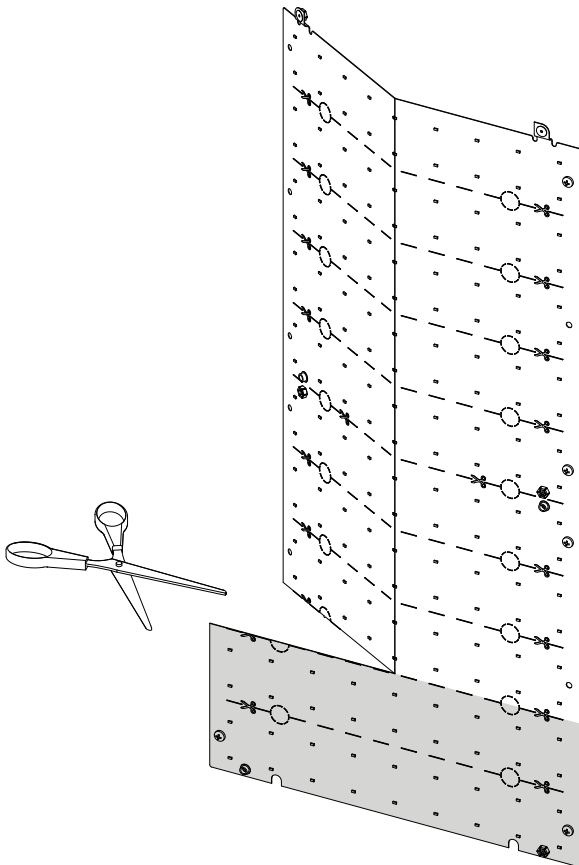
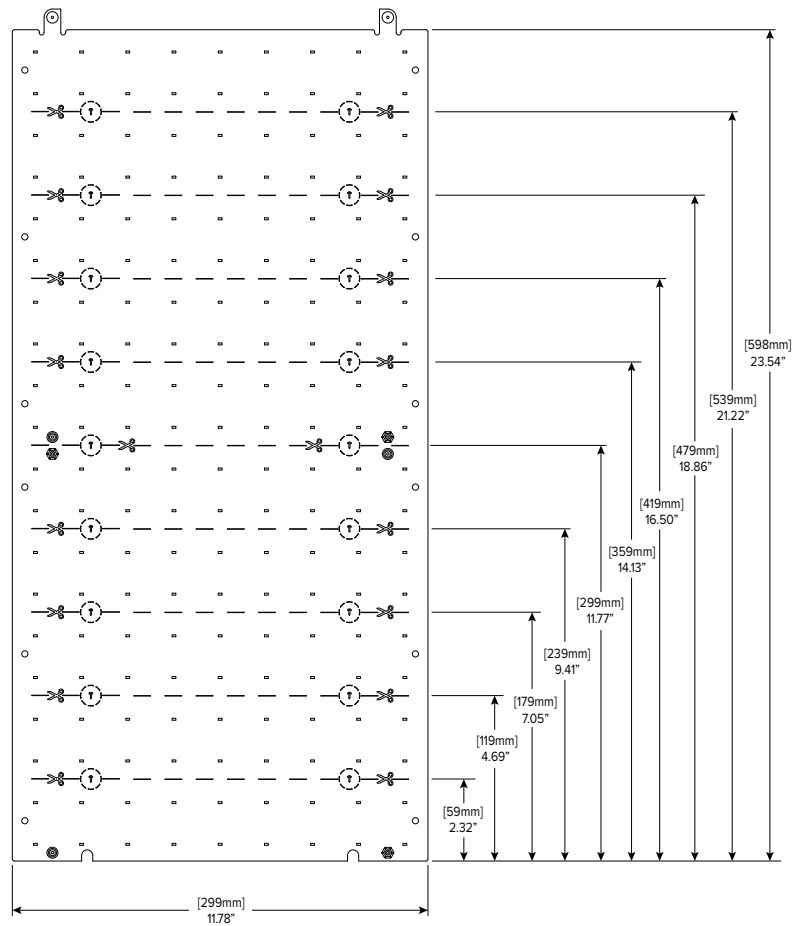

! The cut edges of the TILE are electrically live. After cutting, the exposed edges of the electrical conductors must be insulated with the supplied insulating patches. These patches must be wrapped around both cut edges of the TILE as shown below:

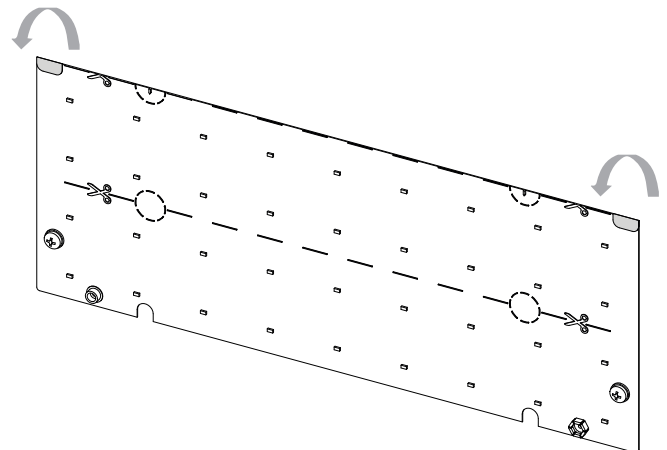

7.3 MOUNT THE ADDITIONAL RUNS OF TILE INTERIOR

NOTE: The following procedure assumes that runs of TILE are to be mounted on 11.8" (300mm) center-to-center spacing to ensure optimal uniformity of illumination. If the design requires different spacing, other methods of alignment may be required.

Additional runs of TILE should be placed immediately adjacent to the preceding run.

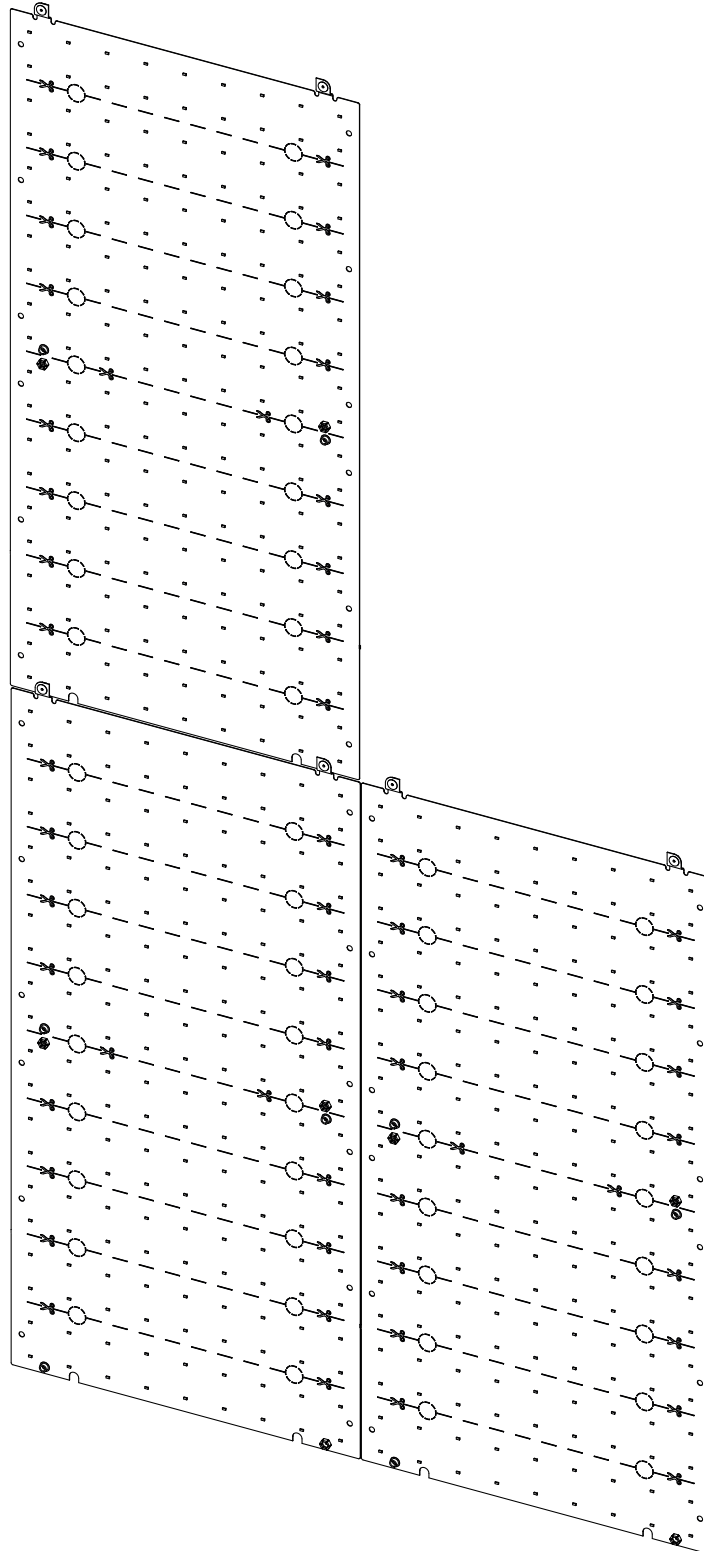

7.4 INSTALL THE LAST RUN (IF LESS THAN 11.8" [300MM] WIDTH)

TILES may not be cut in both directions without breaking the electrical circuits that provide power to the LEDs. For this reason, when installing a run that is <11.8" (300mm) in width, it is necessary to cut the sheets to the required width and then rotate the TILES 90° so that the input end faces the outer edge of the run. Sheets are cut along the cut line identified in Section 7.2 that corresponds with the required width.

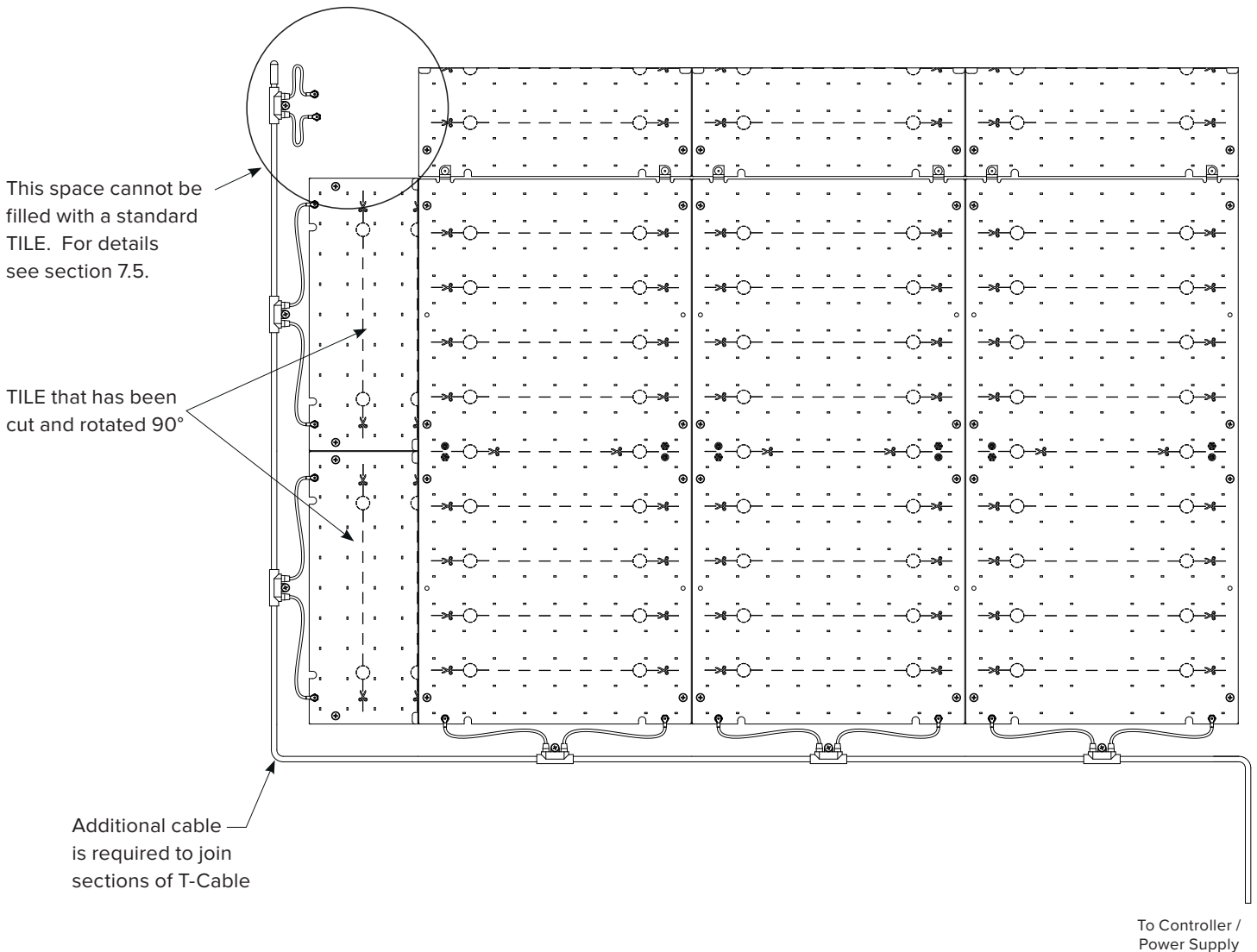

1. The number of TILES that will need to be cut is equal to 2 x the number of rows of full-sized TILES already installed (e.g. if there are three (3) rows of uncut light sheets in the runs already installed, six (6) sheets will need to be cut and rotated to make up the last run). If the cut sections are less than 11.8" (300mm) long, each TILES may be cut in half. Both halves may then be further cut down as needed.
2. Determine the required cut increment (Section 7.2) that will fit into the width remaining.
3. Cut the TILES so that each sheet is equal to or slightly smaller than the required width and retains the snap connectors at the input end of the sheet.
4. Starting at the input end of the previously installed runs, rotate one (1) of the cut TILES Interior 90° ensuring that the snap connectors are facing the side on which the T-cable will be mounted and fasten using appropriate #8 (M4) fasteners as in Section 7.1.
5. Repeat Steps 7.2 and 7.3 until the run has been completed or there is one (1) remaining space that is <11.8" (300mm) in both dimensions.

7.5 INSTALL THE LAST CORNER

For design layouts requiring runs that include end TILE that are cut short and where the last run is less than 11.8" (300mm) in width, there will be a space remaining – the “last corner” – that cannot be filled by cutting a standard TILE.

A TILE Cutout is used to fill in this last corner in any square or rectangular layout. This sheet has been designed to be cut in both directions.

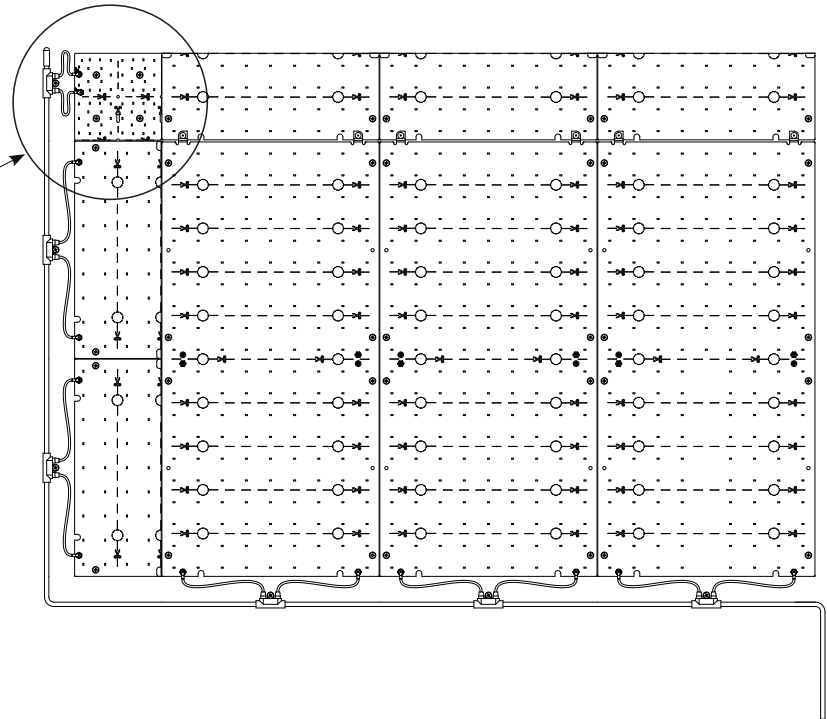

Output End Tabs

1. Determine the size of TILE Cut-Out required. The sheets are sized to correspond to the allowable cut sizes of the standard sheet (each Cut-Out is 5 x 5 cut increments).
2. Cut the Cut-Out to the required size by cutting only along the clear areas between the smaller white square sections. The square section with the snap connectors must always remain as it is the point of electrical connection.
3. Peel the adhesive backing from the Cut-Out and stick it to the mounting surface with the snap connectors facing where the T-Cables will be mounted. Appropriate #8 (M4) fasteners may be added using the holes located in the center of each small square section.

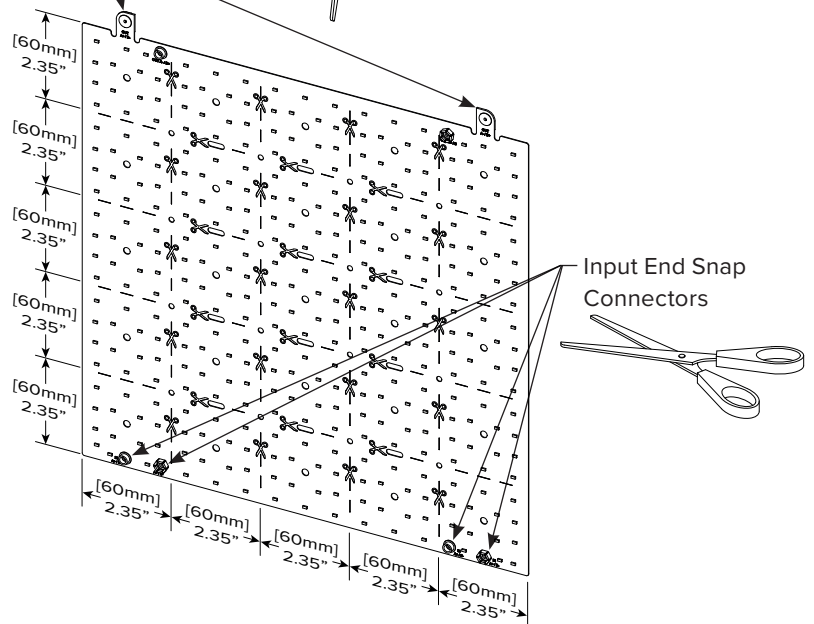

! DO NOT CONNECT the T-Cable at the output (tab) end of the Cutout TILE. The T-Cable can only be connected at the input end of the sheet.

7.6 INSTALL T-CABLES

1. If available, refer to the project shop drawings to locate the input end of the TILE runs. T-Cables are to be mounted adjacent to the input end of the sheets.
2. T-cables are mounted with M4 (#8) screws. These cables can be installed very close to the TILE and in some cases, it may be required that the input end of the TILES overlaps the cables.

TIP: T-Cables may be mounted either to the TILE mounting surface or to an adjacent surface if preferred as shown.

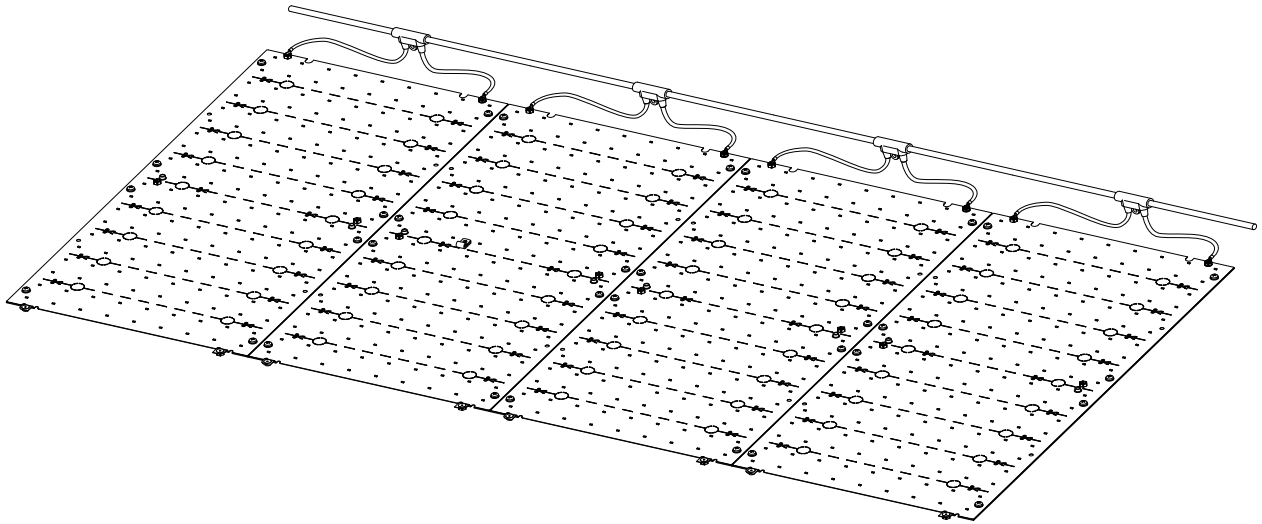

3. T-cables can be cut to length as required. Cutting can be done anywhere on the cables except at the T junctions. After cutting, the end of the cable must be insulated using the T-cable end cap. Slide the end cap over the cable until the cable is fully inserted.

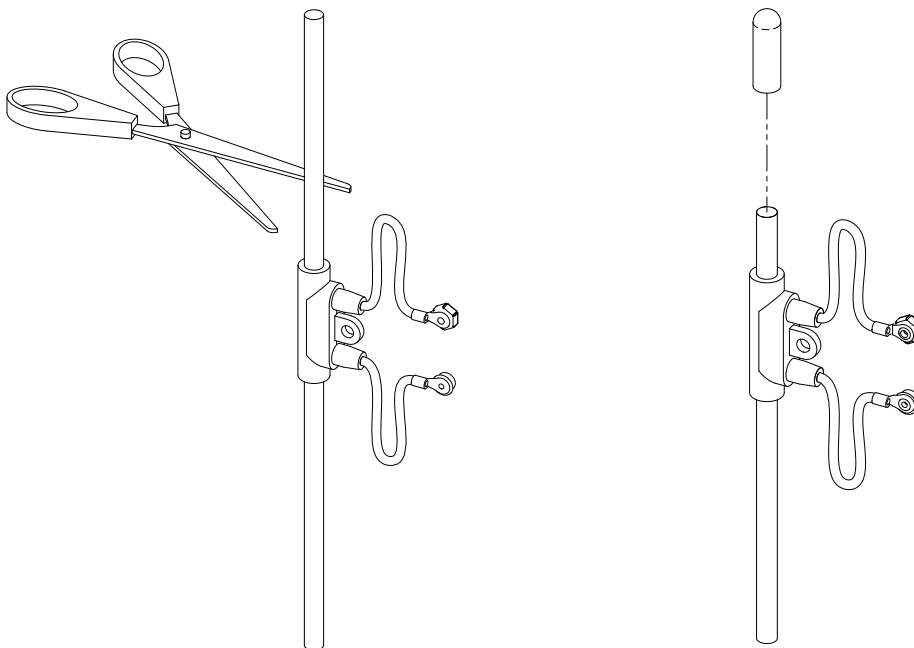

7.7 DISASSEMBLING TILES (IF REQUIRED)

 Caution - the snap connectors are not intended for repeated connections. If it is necessary to separate the sheets after the snap connectors have been mated together, it can be done as follows:

1. Use one hand to restrain the TILE sheets as shown.

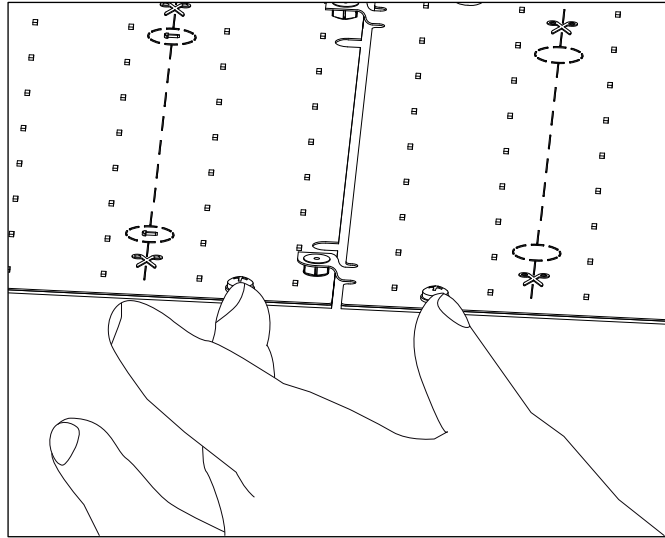

2. Grip the tab between the thumb and index finger. Gently separate the sheets while keeping the sheets restrained.

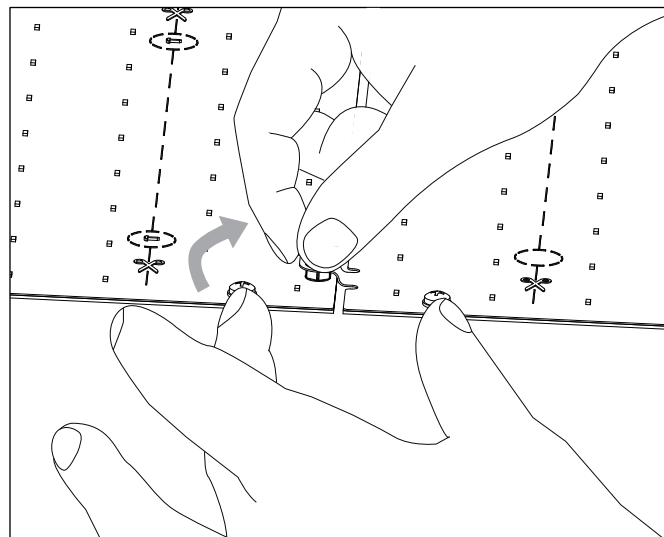

3. Similarly, when disconnecting T-cables from the TILE Interior, the sheet should be restrained while gently separating the connectors.

7.8 REUSE OF INPUT END OF TILE (IF REQUIRED)

It is possible to cut a TILE in half and reuse both portions in the layout.

The output half of the TILE retains the output tabs and can be incorporated into the layout just like a standard TILE.

The input half of the TILE will have snap connectors at its output end, but no tabs. The Cut TILE Reuse Jumper cable can be used to connect these snap connectors to another light sheet.

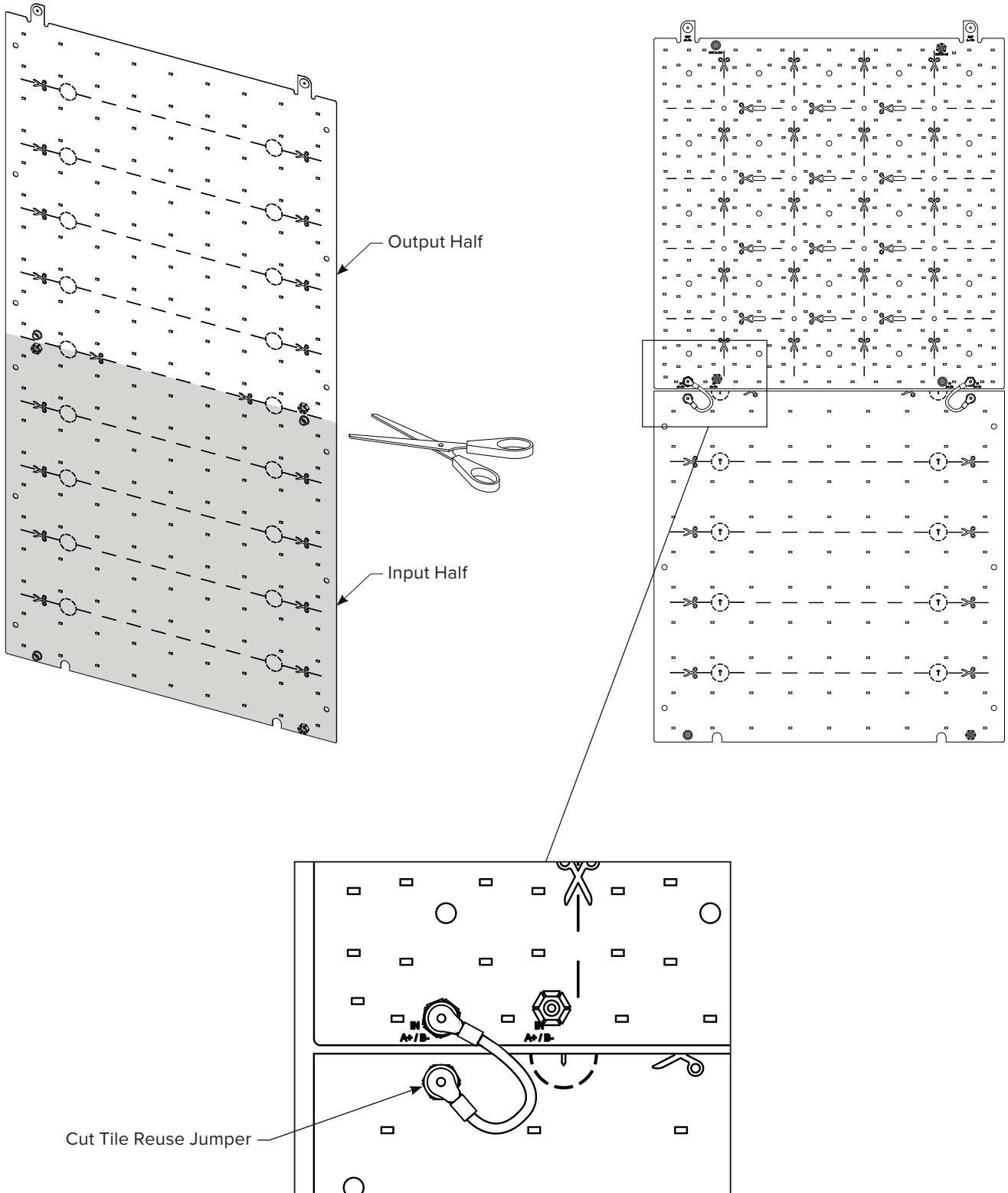

8.0 TILE INTERIOR/TUNABLE WHITE LAYOUT GUIDELINES

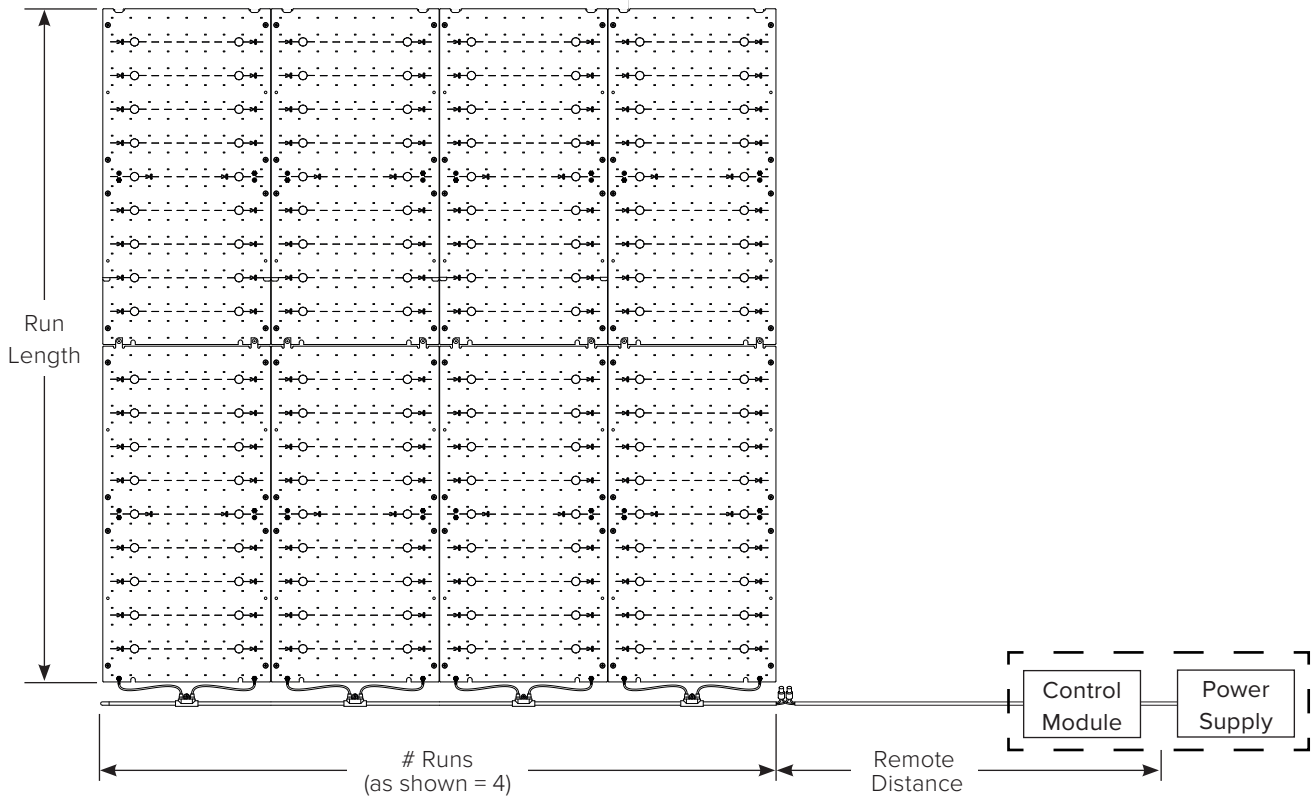

8.1 CALCULATING MAXIMUM RUN LENGTH

Use the following table to determine the maximum run length possible based on the number of runs, the light output of the TILES, and the CCT for one (1) 90W channel. The values shown correspond to the nearest cut increment of the TILE.

MAXIMUM RUN LENGTH - VALUES IN FEET										
# of Runs	600 lm/sqft (TILE-xxx-600)					300 lm/sqft (TILE-xxx-300)			150 lm/sqft (TILE-xxx-150)	
	2200K	2700K	3000K	3500K / 4000K	5700K	2200K / 2700K	3000K / 3500K	4000K / 5700K	2200K / 2700K	3000K - 5700K
1	13.6	15	16.1	16.7	16.7	21.7	23.6	24.6	32.5	35.4
2	6.7	7.5	8.1	8.3	8.7	14.2	16.5	17.7	28.5	31.5
3	4.5	4.9	5.3	5.5	5.7	9.4	11	11.8	19.7	23.6
4	3.3	3.7	3.9	4.1	4.3	7.1	8.3	8.9	14.8	17.7
5	2.6	3	3.1	3.3	3.3	5.7	6.5	7.1	11.8	14.2
6	2.2	2.4	2.6	2.8	2.8	4.7	5.5	5.9	9.8	11.8
7	1.8	2	2.2	2.4	2.4	3.9	4.7	4.9	8.3	9.8
8	1.6	1.8	2	2	2	3.5	3.9	4.3	7.5	8.9

Notes: For TILE Tunable White - TNW, use the 2700K column
 For TILE Tunable White - DTW (dim-to-warm), use the 2200K column

Example 1: 3000K; 600lm/sqft; 4 Runs (as shown in the diagram above)

- Using the table, the corresponding value for this configuration is 3.9ft. This means that two full regular TILES may be used without being cut for each of the 4 runs.

Example 2: 2700K; 150 lm/sqft; 4 Runs

- Using the table, the corresponding value for this configuration is 14.8ft. This means that 7.5 regular TILES may be used.

MAXIMUM RUN LENGTH - VALUES IN M										
# of Runs	6450 lm/m ² (TILE-xxx-600)					3225 lm/m ² (TILE-xxx-300)			1600 lm/m ² (TILE-xxx-150)	
	2200K	2700K	3000K	3500K / 4000K	5700K	2200K / 2700K	3000K / 3500K	4000K / 5700K	2200K / 2700K	3000K / 5700K
1	4.14	4.56	4.92	5.1	5.1	6.6	7.2	7.5	9.9	10.8
2	2.04	2.28	2.46	2.52	2.64	4.32	5.04	5.4	8.7	9.6
3	1.38	1.5	1.62	1.68	1.74	2.88	3.36	3.6	6	7.2
4	1.02	1.14	1.2	1.26	1.32	2.16	2.52	2.7	4.5	5.4
5	0.78	0.9	0.96	1.02	1.02	1.74	1.98	2.16	3.6	4.32
6	0.66	0.72	0.78	0.84	0.84	1.44	1.68	1.8	3	3.6
7	0.54	0.6	0.66	0.72	0.72	1.2	1.44	1.5	2.52	3
8	0.48	0.54	0.6	0.6	0.6	1.08	1.2	1.32	2.28	2.7

Example 1: 3000K; 6450lm/m²; 4 Runs (as shown in the diagram above)

- Using the table, the corresponding value for this configuration is 1.2m. This means that two full regular TILES may be used without being cut for each of the 4 runs.

Example 2: 2700K; 1600lm/m²; 4 Runs

- Using the table, the corresponding value for this configuration is 4.5m. This means that 7.5 regular TILES may be used.

8.2 CALCULATING REMOTE POWER & CONTROL DISTANCE

Due to a voltage drop caused by the resistance of the cable carrying power between the Power Supply/Control Module and the TILES, there is a maximum distance from the TILES at which the power and control units may be mounted.

The maximum distance is dependent upon the size of the conductors used and the total load (# of TILES x power per TILE as determined by lumen rating)

Use the tables below to determine the size of the conductors required to achieve the maximum “remote distance” – the distance between the Control Module and TILES if the Control Module is located near the power supply OR the total distance between the Power Supply and TILES if the Control Module is located near the TILES.

MAXIMUM REMOTE DISTANCE - TILE 150LM (VALUES IN FT)

Conductor Size (AWG)	Configuration (# Runs x Maximum Length per Run)							
	1 x max length (ft)	2 x max length (ft)	3 x max length (ft)	4 x max length (ft)	5 x max length (ft)	6 x max length (ft)	7 x max length (ft)	8 x max length (ft)
16	11.5	10.5	18.5	23	24	24	23.5	22
14	18	17	29.5	37	38.5	38.5	38	35
12	29	27	47.5	59	61.5	61	60.5	56
10*	46	43	75.5	93.5	98	97.5	96	89

MAXIMUM REMOTE DISTANCE - TILE 300LM (VALUES IN FT)

Conductor Size (AWG)	Configuration (# Runs x Maximum Length per Run)				
	1 x max length (ft)	2 x max length (ft)	3 x max length (ft)	4 x max length (ft)	5 x max length (ft)
16	10.5	18.5	26	27	27
14	17	30	41.5	43.5	43
12	27	47.5	66	69	68.5
10*	43.5	76	104.5	110	109

MAXIMUM REMOTE DISTANCE - TILE 600LM (VALUES IN FT)

Conductor Size (AWG)	Configuration (# Runs x Maximum Length per Run)			
	1 x max length (ft)	2 x max length (ft)	3 x max length (ft)	4 x max length (ft)
16	10.5	27	29.5	29
14	16.5	43	47	46.5
12	26.5	68.5	75	74
10*	42.5	109	119	118

*The control module accepts wire gauges in the range of 12-26AWG. The 10AWG numbers in the chart are based on connecting on short length of 12AWG wire to the control module and then splicing on a subsequent length of 10AWG wire to supply the TILES.

Example

- Required “remote distance” = 50ft
- TILE Light Output = 600lm/sqft
- # Runs = 3 (assumes maximum run length)

Therefore, conductor size required = 14AWG (or larger)

MAXIMUM REMOTE DISTANCE - TILE 150LM (VALUES IN M)

Conductor Size (mm ²)	Configuration (# Runs x Maximum Length per Run)							
	1 x max length (m)	2 x max length (m)	3 x max length (m)	4 x max length (m)	5 x max length (m)	6 x max length (m)	7 x max length (m)	8 x max length (m)
1.3	3.5	3.2	5.6	7	7.3	7.3	7.2	6.7
2.1	5.5	5.2	9	11.3	11.7	11.7	11.6	10.7
3.3	8.8	8.2	14.5	18	18.7	18.6	18.4	17.1
5.3	14	13.1	23	28.5	29.9	29.7	29.3	27.1

MAXIMUM REMOTE DISTANCE - TILE 300LM (VALUES IN M)

Conductor Size (mm ²)	Configuration (# Runs x Maximum Length per Run)				
	1 x max length (m)	2 x max length (m)	3 x max length (m)	4 x max length (m)	5 x max length (m)
1.3	3.2	5.6	7.9	8.2	8.2
2.1	5.2	9.1	12.6	13.3	13.1
3.3	8.2	14.5	20.1	21	20.9
5.3	13.3	23.2	31.9	33.5	33.2

MAXIMUM REMOTE DISTANCE - TILE 600LM (VALUES IN M)

Conductor Size (mm ²)	Configuration (# Runs x Maximum Length per Run)			
	1 x max length (m)	2 x max length (m)	3 x max length (m)	4 x max length (m)
1.3	3.2	8.2	9	8.8
2.1	5	13.1	14.3	14.2
3.3	8.1	20.9	22.9	22.6
5.3	13	33.2	36.3	36

*The control module accepts wire sizes in the range of 0.13mm² to 3.3mm². The 5.3mm² numbers in the chart are based on connecting on short length of 3.3mm² wire to the control module and then splicing on a subsequent length of 5.3mm² wire to supply the TILES.

Example

- Required “remote distance” = 15m
- TILE Light Output = 6450lm/m²
- # Runs = 3 (assumes maximum run length)

Therefore, conductor size required = 3.3mm² (or larger)

COOLEEDGE CABLES

- Cooledge supplies Starter Cables 16AWG (1.3mm²) of length = 10ft (3m). These cables can also be purchased individually.
- 14AWG (1.5mm²) extension cables in 10’(3m) and 20’(6m) lengths are also available.
- Other cable sizes (if required) are supplied by installer.

9.0 TROUBLESHOOTING

If the TILE Interior does not illuminate when power is applied:

- Check to ensure all electrical connections have been made.

If a single LED or one (1) section of LEDs on a TILE does not illuminate:

- The circuit for those LEDs has likely been damaged and the TILE Interior should be replaced.

10.0 PRODUCT SUPPORT

Contact Cooledge Technical Support at:

- E: apps.engineering@cooledgelighting.com
- O: +1.781.899.0317
- T: 1.844.455.4448 (toll free – North America)

11.0 WARRANTY

Cooledge warrants that the products manufactured, distributed or sold by it will:

- | | |
|----|---|
| 1. | Be free of any claim of ownership by third parties. |
| 2. | Be conforming to the Specifications and free from defects in materials and workmanship under normal use, handling, warehousing and service. |

The warranty period specified in the Cooledge Warranty Terms and Conditions for the products will be for a period of five (5) years from the shipment date of any products sold by Cooledge.



In Canada, TILE Interior
must be installed within
an enclosure

RoHS



5 Year Limited Warranty:
Parts and workmanship

Cooledge Lighting Inc.
120-13551 Commerce Parkway
Richmond, BC V6V 2L1 Canada

O +1 604 273 2665
F +1 604 273 2660
T +1 844 455 4448
W cooledgelighting.com

Cooledge Lighting reserves the right to change
materials or modify the design of its product
without notification as part of the company's
continuing product improvement program.